

BRASCH

GAS DETECTOR CONTROL PANEL (TWENTY CHANNEL)

Model GDCP-A

Instruction/Operation Manual

Bulletin: I-690

**Brasch Environmental Technologies, LLC
140 Long Road, Suite 101
Chesterfield, Missouri 63005
(314) 291-0440 FAX (314) 291-0646
www.braschenvtech.com**

**July 2006
May, 2007
April, 2009
March, 2019**

Table of Contents

Section	Title	Page
1	Introduction and Specifications	6
1-1	Introduction	6
1-2	Model Description	6
1-3	Specifications	7
2	Installation	10
2-1	Introduction	10
2-2	Unpacking and Inspection	10
2-3	Choosing the Mounting Location	10
2-4	Mounting the Panel	10
2-5	Wiring Connections	12
3	Operation	18
3-1	Introduction	18
3-2	Applying Power	18
3-3	Initial Display	19
3-4	Default Program	20
3-5	Entering or Changing an Existing Program	22
3-5.1	Time	22
3-5.2	Date	22
3-5.3	Sensors	23
3-5.4	Zones	23
3-5.5	Automatic Override	24
3-5.6	Manual Override	24
3-5.7	Power Restore After a Power Interruption	25
3-6	Status Check	25
3-6.1	Sensors	25
3-6.2	Zones	26
3-6.3	Automatic Override	26
3-7	Loss of Power	27
3-7.1	Operation During Power Loss	27
3-7.2	Operation After Power Returns	27
3-7.2.1	Power Restore Without Ventilation	27
3-7.2.2	Power Restore With Ventilation	27
4	Maintenance	28
4-1	Introduction	28
4-2	Sensors	28
4-3	Fuses	28
4-4	Sensitivity Testing	28
5	Service and Repair	29
5-1	Introduction	29
5-2	Warranty Period	29
5-3	Obtaining Service	29
5-3.1	Service and Repair Procedure	29

6	Appendix	Page
	Appendix A	30
	Appendix B	31
	Appendix C	33
	Appendix D	34
	Appendix E	35

List of Figures

Figure	Title	Page
1	GDCP-A mounting dimensions	11
3	GDCP-A internal components, view from bottom end	13
4	GDCP-A power connection terminals	14
5	GDCP-A digital logic board component layout	15
6	GDCP-A wiring diagram showing transmitters wired in “daisy-chain” fashion, and location of terminals strips TS1 and TS2.	17
7	GDCP-A front, internal view of front panel layout	21

List of Tables

Table	Title	Page
1-3.1	GDCP-A Control Panel Specifications	7
2-5.2	Explanation of the connection points on terminals TS1 and TS2.	16

Operation Safety Notice

Certain procedures and operations detailed in this manual require that specific precautions be taken prior to beginning the procedure or operation. When precautions are required, a notice will be printed in an appropriate location in the manual. The user is urged to read and understand all such notices before continuing.

Types of Notices

Three types of notices are used in this manual to describe the severity of the situation encountered.

WARNING This notice indicates that conditions exist that could cause personal injury or loss of life.

CAUTION Conditions exist that could cause damage to the equipment or other property.

Note Special consideration should be given to the procedure or operation or an unexpected operational result could occur.

Limited Warranty

Warranty Statement

Limited Warranty

Brasch Environmental Technologies, LLC, (**the Company**), warrants gas transmitters, detectors, control panels, and accessories for a **period of one year from the date of shipment** against defects in material or workmanship. Should any evidence of defects in material or workmanship occur during the warranty period, Brasch Environmental Technologies will repair or replace the affected product, **at its own discretion**, without charge. **The Company shall not be held responsible for any charges incurred by any other company or person while installing, removing or replacing any allegedly defective equipment, or part thereof, nor for incidental or consequential damages.**

Section 1

Introduction and Specifications

1-1 Introduction

1-1.1 This manual covers the capabilities, installation, set-up and operation of the Brasch GDCP-A Control Panel. The panel and its associated transmitters are referred to as the **ventilation control system**. These systems can be as simple as a panel and one transmitter controlling one ventilation fan, or as complex as a panel with 20 transmitters controlling six output zones with two ventilation fans each.

The user is strongly encouraged to read, and understand, this entire manual before attempting to install and operate this equipment.

1-2 Model Description

1-2.1 The Brasch GDCP-A Control Panel, along with its associated transmitters, provides a complete monitoring system for detection and removal of dangerous concentration of specific toxic gases. The system is capable of monitoring up to 20 remote locations for gases such as carbon monoxide and nitrogen dioxide. The panel can then provide control signals, based upon the actual gas concentration, to actuate warning alarms and operate ventilation equipment within the monitored area.

The panel can control up to six ventilation zones. Two, dry-contact, normally open, control relays are provided for each zone. The Low Alert set of contacts have ten field adjustable levels. The concentrations of these levels are dependent upon the type of gas being monitored. **See Appendix E for the actual Low Alert values.** The High Alert set of contacts are factory set to close at a predetermined level. This level is 100 parts per million, (PPM), for carbon monoxide and 5 PPM for nitrogen dioxide. The Low Alert relay contacts will close, (open), once the gas level is above, (below), the field selectable level and a field selectable delay period has timed out. The High Alert contacts will close, (open), once the levels are above, (below), the factory preset concentrations.

A dry-contact, normally open relay, that is common to all of the six control zones, will close 15 minutes after a High Alert level is exceeded and maintained. Once the High Alert level drops below the factory settings, this relay will again revert to the normally open state. This relay may be used to send warning signals to remote locations, or actuate external alarm components to provide additional warnings. A piezoelectric buzzer, mounted beneath the GDCP-A's front panel, will also sound while the relay contacts are closed. This buzzer may be silenced by pressing and then releasing the "ALM OFF" switch located directly below the buzzer sound venting holes on the right side of the front panel. This switch will automatically reset itself after the alarm condition is no longer valid.

The GDCP-A Control Panel can be field programmed to suit the user's requirements. Program choices are displayed on the 4 lines of a 20 character per line, liquid crystal display. The appropriate choice is selected through the use of a four key keypad located directly below the display. The active keys

associated with the current choice are noted on the fourth line of the display. In most cases, the keys that are not listed are inactive at this time.

Programmed parameters are stored in a non-volatile memory circuit. In the case of power failure, this circuit will retain the programmed parameters for a nominal period of ten years. This extremely long retention time allows the GDCP-A to be programmed at the factory with the user's specific program data. Once the unit arrives at the user's facility, and is placed in operation, no further programming is necessary. The user may make changes to the program, however, once the system is operating.

To take advantage of the factory programming feature, the user must convey their programming requirements to the factory at the time their order is placed. If no special programming is requested, the panel will ship programmed with a default program.

1-3 Specifications

1-3.1 Specifications for the GDCP-A Control Panel are listed in **Table 1-3.1**.

Note

All specifications were current at the time this manual was printed. Brasch Environmental Technologies, LLC reserves the right to make any changes to future production units when such changes are deemed necessary. **There is no implied responsibility to make future changes available to current users of this equipment.**

Table 1-3.1 GDCP-A Control Panel Specifications

Electrical	
Power requirements	
Voltage	120 VAC, +/- 10 %
Frequency	50/60 Hz.
Inductive power	120 VA
Installation category	II (Local level, over-voltage transients below 1500 volts.)
Environmental	
Temperature	
Operating	-15° C to 40° C, (5° F to 104° F)
Storage	-50° C to 120° C, (-58° F to 248° F)
Humidity	
Operating	10% to 90%, (non-condensing)
Storage	10% to 90%, (non-condensing)

Table 1-3.1 GDCP-A Control Panel Specifications, (continued)

General	
Size	14 in. W. x 10 ¼ in. H. x 5 in. D. 35.6 cm. W. x 26.0 cm. H. x 12.7 cm. D.
Weight	14 Lbs. (6.36 KGs)
Housing	Heavy gauge, painted steel, NEMA 1 classification.
Recognition	
Agency	ETL listed to U.L. Standard 61010B-1 and Canadian CSA C22.2, NO 1010-1
System, Electrical	
Display	20 char. X 4 line LCD with LED backlight
Keypad	5 embossed keys with tactile feedback
Timing	Real-time clock with output for minutes, hours, day-of-week, day, month and year.
Circuit	Microprocessor controlled digital circuitry with battery backup, (nominal 10 year lifetime).
Input channels	
Number	20 inputs, (max.)
Input signal	8-bit digital word, RS-485 transceiver
Connection	Inputs are true daisy-chain, both power and communication.
Maximum distance	1000 feet between input transmitter and panel.
Output channel	
Number	6 outputs, (max.)
Type of output	Two each, dry-contact, mechanical relays, fused at 5 Amps.
Maximum voltage rating	125 VAC, 50/60 Hz.
Current capacity	5 Amps, resistive at 30 VDC.
Power (inductive)	250 VA, (1/8 H.P.)

Table 1-3.1 GDCP-A Control Panel Specifications, (continued)

Alarm channel		
	Number	Two each, common to all output channels
	Type	
	External	
	Type	One each, dry-contact, mechanical relay, fused at 5 Amps.
	Maximum voltage	125 VAC, 50/60 Hz.
	Current capacity	5 Amps, (resistive) at 30 VDC
	Power, (inductive)	250 VA, (1/8 H.P.)
	Internal	
	Type	Piezoelectric ceramic element
	Frequency	3.7 KHz.
	Sound level	110 db. @ 10 cm.

Section 2 Installation

2-1 Introduction

2-1.1 This section of the manual provides instructions on the initial procedures required to make your GDCP-A Control Panel operational. In the following paragraphs, you will find detailed instructions on unpacking and inspection, locating and mounting the panel and connecting the wiring.

If for any reason, you have questions concerning the panel that are not answered in this manual, please contact your distributor or Brasch Environmental Technologies at the number listed on the front of this manual.

2-2 Unpacking and Inspection

2-2.1 Depending upon the number of transmitters ordered, you may receive the GDCP-A Control Panel system in more than one container. In any case, carefully unpack all containers and check the contents against your purchase order. Report any missing components to your distributor. Your distributor will immediately contact Brasch Environmental Technologies and inform us of the discrepancy. You should save the packing containers in case there is a reason to return any of the shipment to the factory at a later date.

2-3 Choosing the Mounting Location

2-3.1 The GDCP-A is designed to allow the remote monitoring of facilities such as underground garages, maintenance facilities, large warehouses and enclosed cargo terminals. Usually the panel is mounted in a utility room, electrical service room, or a guard house where the data gathered from the remote transmitters can be conveniently monitored. Other than the requirement that the panel be within 1000 feet of the most remote transmitter, easy access to the front panel display will most likely determine the optimum mounting location.

Choose a location with easy access to the front panel controls. Remember that not only will you require enough room to fully open the housing cover, but also there must be enough room around the panel for routing and connecting the various wiring conduits. The availability of a **dedicated, 120 VAC power line** is a must for proper operation. **Do not try to operate this system without a dedicated line supplying the panel power. This line should not be shared with the control voltage that operates the fan motor control relays. Huge electrical spikes, produced whenever these relays operate, can cause the digital circuits in the panel to malfunction.**

2-4 Mounting the Panel

2-4.1 Mount this panel only indoors in a dry location. Ensure that the user has easy access to the front panel controls and that the display can be easily read.

The housing is equipped with mounting holes placed in the top and bottom edges of the housing's back. **Please see Fig. 1, page 11, for the location of these holes as well as the required mounting dimensions. Also, a full size**

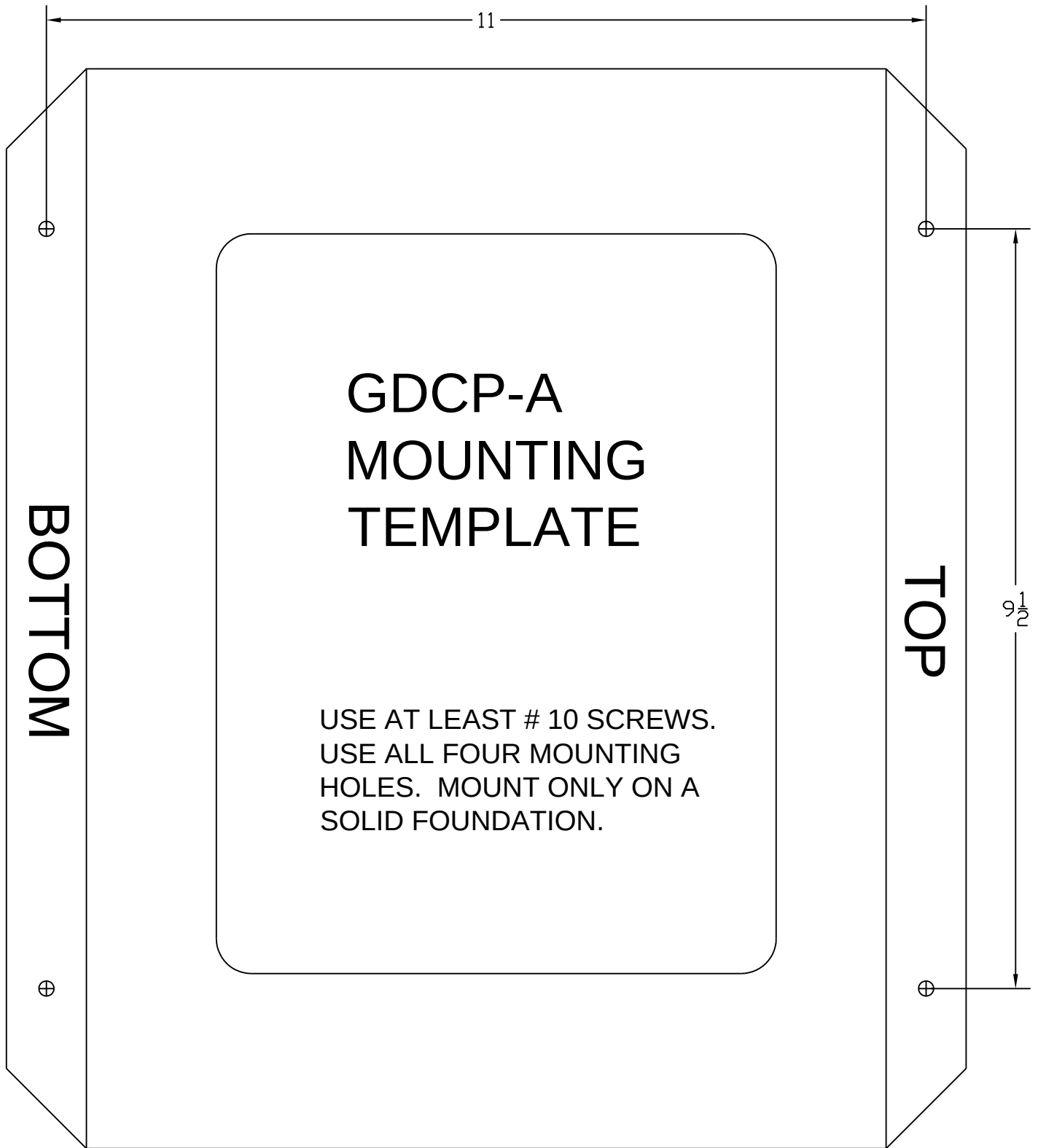

FIG. 1: GDCP-A mounting dimensions.

template is enclosed with the important papers shipped with the panel, and may be used to locate the mounting holes. Attach the housing to a wall, or other solid support, using only these holes. **This unit must not be mounted by drilling or punching holes in the inside of the housing. Metal shavings, or other foreign objects, may cause damage to the panel's circuit boards. The damage created would, of course, not be covered by the manufacturer's warranty.**

Mount the panel with at least #10 screws through all four holes. Make sure that the screws are driven in fully and that the mounting surface is strong enough to support the panel's weight.

2-5 Wiring Connections

- 2-5.1** This control panel is designed to operate from **120 VAC power at 50/60 Hz.** The power circuit must be able to supply at least **120 VA** to the panel. **This supply circuit must include a disconnect device or switch located within easy reach adjacent to the panel's location. This component must be clearly labeled as the disconnect device for the panel.**

Use 12 or 14 AWG, stranded wires to provide the 120 VAC power to the control panel. Although the panel uses less than 0.5 Amps of operating current, extremely long lengths of wiring between the service breaker and the panel could result in large voltage drops occurring across the wire lengths. If long lengths of wiring are required, use 12 AWG wiring for the supply circuit.

The power connections are made on the **Power Supply/Relay P.C. board.** **Fig. 3, page 13,** shows an internal, bottom view of the assembled panel. Use this figure to locate the Power Supply/Relay board. **Fig. 4, page 14,** shows the location of the power terminal strip, TS1, where these connections are made. **L1 is for the 120 VAC hot lead, while the 120 VAC neutral wire connects to L2. The four ground points on terminals 3 through 6 can be used to attach the circuit earth ground.**

- 2-5.2** Connections between the panel and the transmitters require a five conductor, shielded cable. **This cable should have 18 AWG, stranded conductors.** Each conductor should have a distinct color to avoid any wiring errors at either the panel or transmitters. This cable provides both the operating voltage to the transmitters and the digital communication lines between each transmitter and the control panel.

The transmitters can be connected in a parallel fashion. This connection scheme is sometimes referred to as a daisy chain connection. The farthest transmitter should be at, or less than, 1000 feet from the panel. The panel contains two terminal strips for connecting the transmitter cable. As many as four cables can be connected at the control panel. Fig. 5, page 15, shows the location of these terminal strips. The function of each terminal point is written directly next to each point. Table 2-5.2, on page 16, explains the function of each terminal point on these strips.

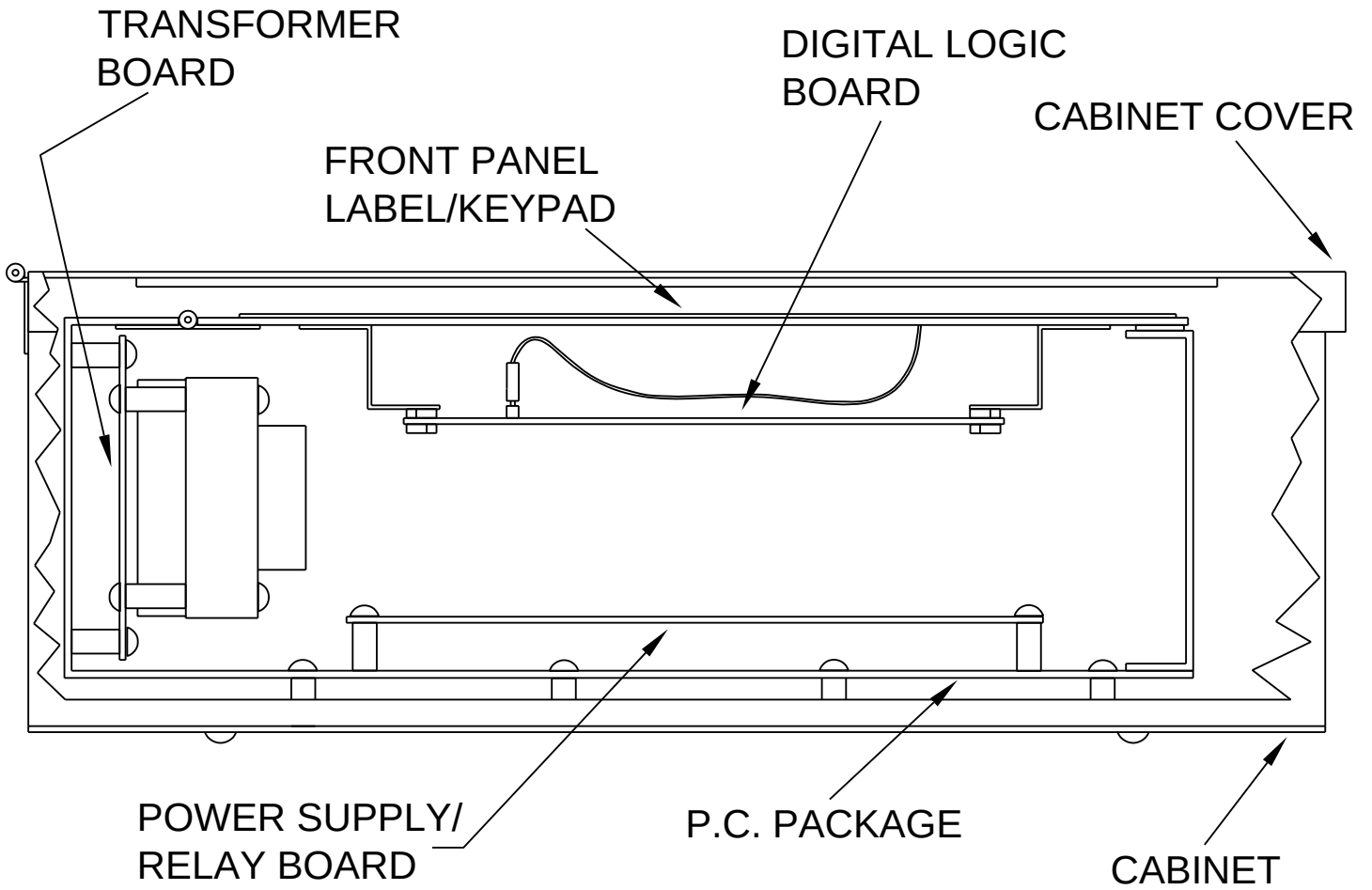

FIG 3: GDCP-A internal components, view from bottom end.

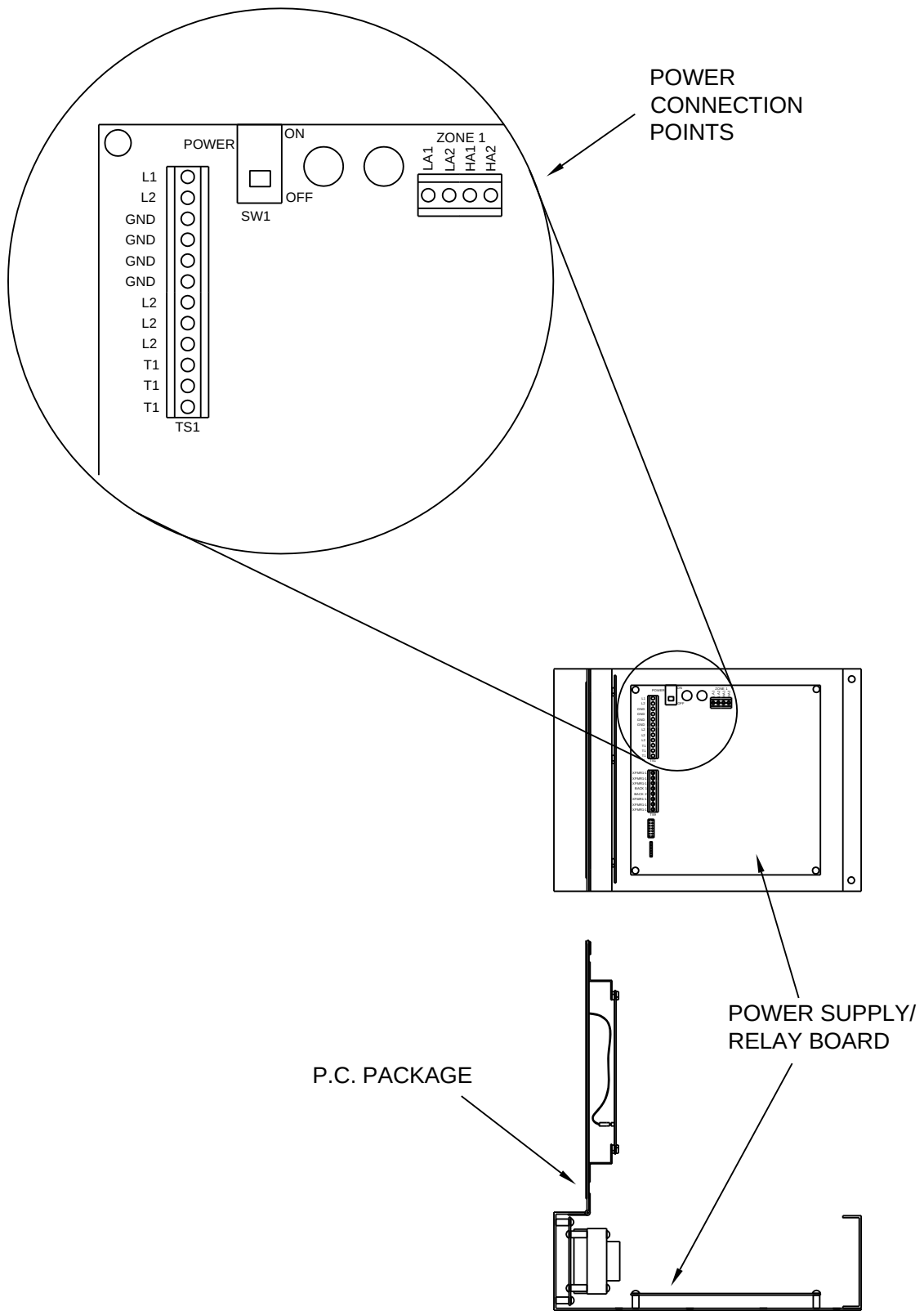

FIG. 4: GDCP-A power connection terminals.

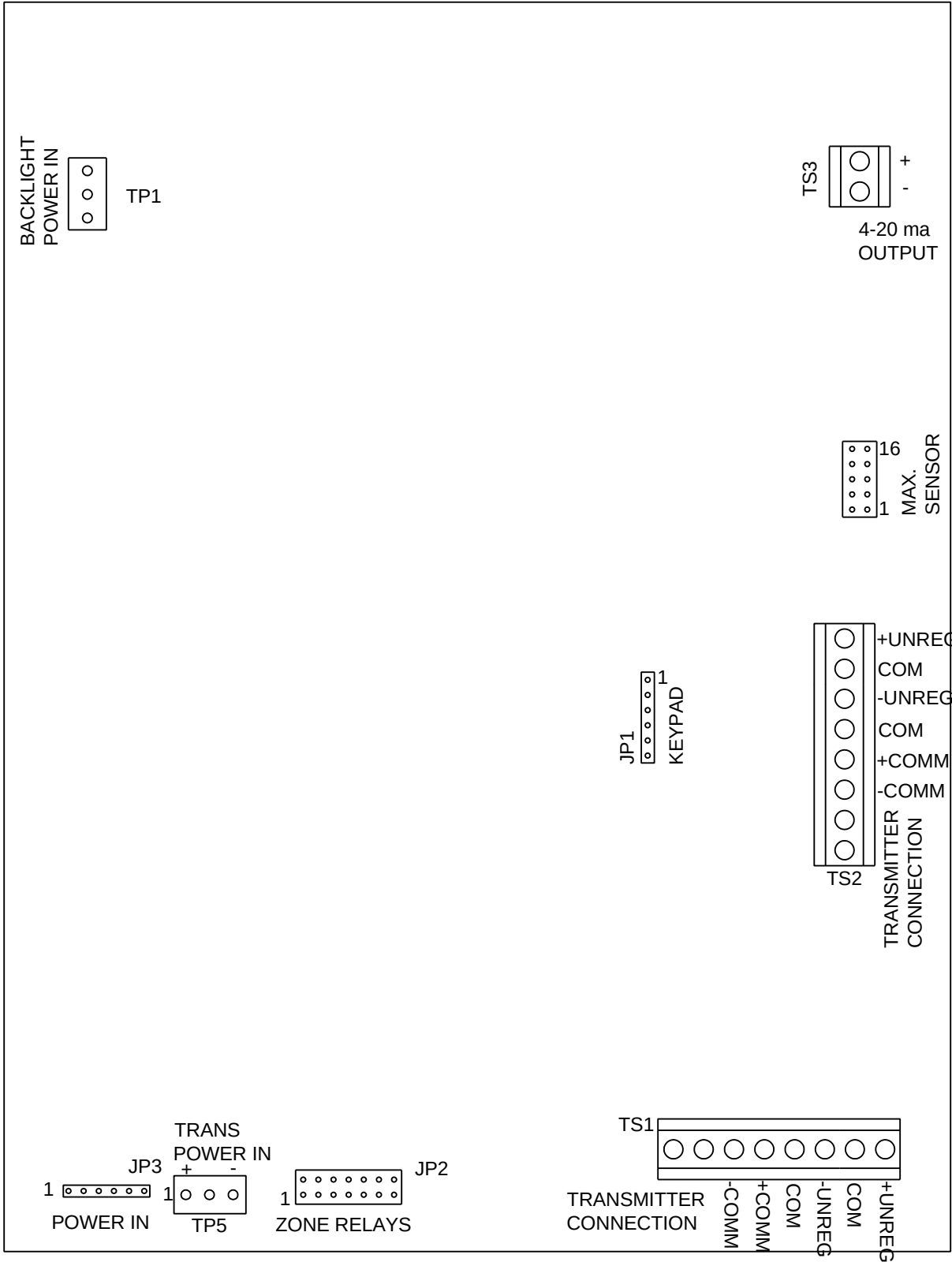

FIG 5: GDCP-A digital logic board component layout.

Table 2-5.2: Explanation of the connection points on terminals TS1 and TS2

Terminal	Identifier	Function
#1	+UNREG	Supplies the unregulated positive DC voltage for the +15 VDC power supply.
#2	COM	Common connection for all circuit points.
#3	-UNREG	Supplies the unregulated negative DC voltage for the -15 VDC power supply.
#4	COM	Common connection for all circuit points.
#5	+COMM	Provides one side of the RS-485 communications port.
#6	-COMM	Provides the second side of the RS-485 communications port.

See FIG. 5, page 15, for the location of these terminal strips.

Connect the shielded cable as shown in **Fig. 6, page 17**, being very careful to avoid mistakes. Either of the two terminal strips, TS1 and TS2, can be used to connect to the transmitters. The two terminals will come in handy if the transmitters fan out in opposite directions from the panel.

Be sure that all of the transmitters that will be assigned to the system are wired correctly before applying power to the panel. The panel initially polls its active transmitters when power is first applied in order to obtain a list of the transmitter types. The panel will consider any transmitters not connected as failed sensors and indicate this on the display.

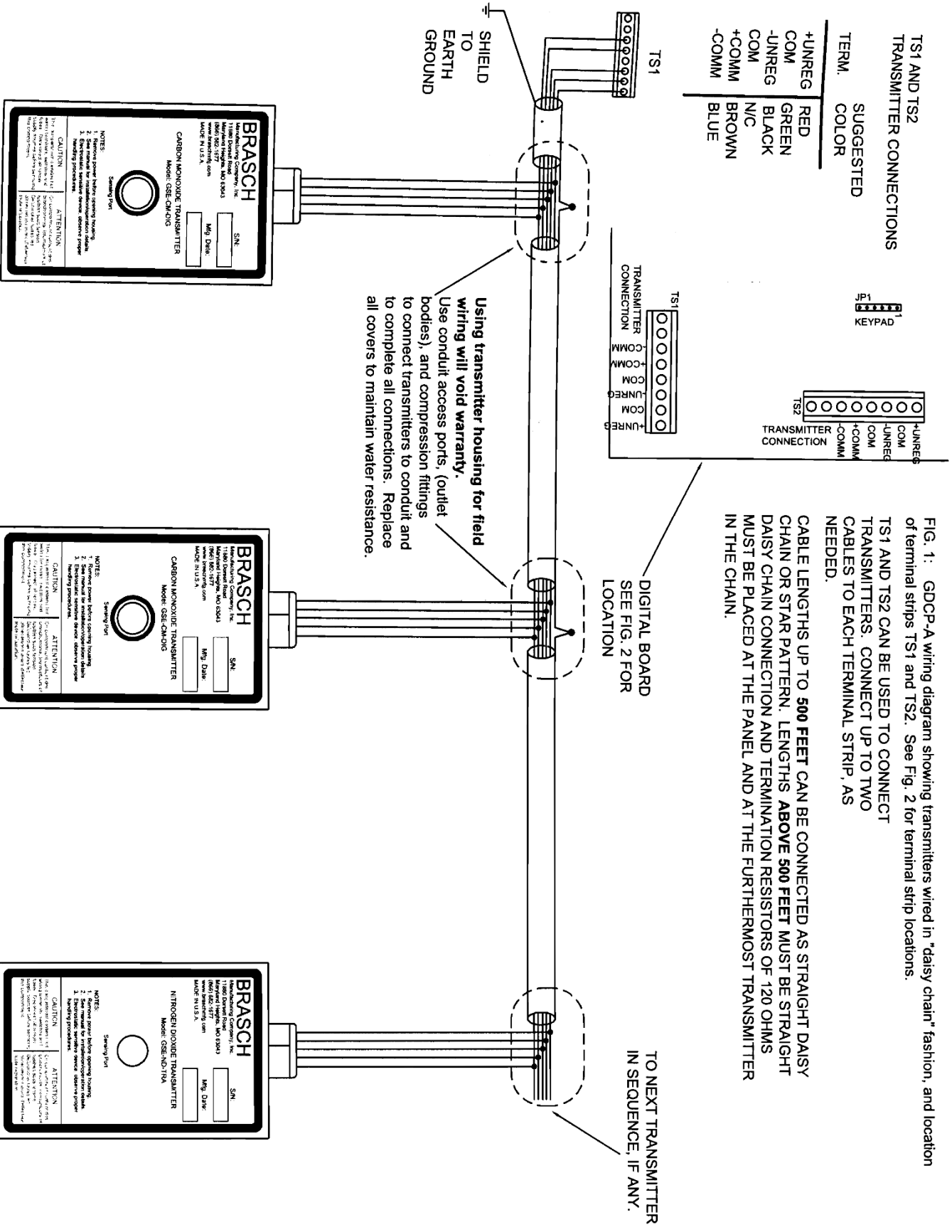

FIG. 1: GDCP-A wiring diagram showing transmitters wired in "daisy chain" fashion, and location of terminal strips TS1 and TS2. See Fig. 2 for terminal strip locations. TS1 AND TS2 CAN BE USED TO CONNECT TRANSMITTERS. CONNECT UP TO TWO CABLES TO EACH TERMINAL STRIP, AS NEEDED. CABLE LENGTHS UP TO 500 FEET CAN BE CONNECTED AS STRAIGHT DAISY CHAIN OR STAR PATTERN. LENGTHS ABOVE 500 FEET MUST BE STRAIGHT DAISY CHAIN CONNECTION AND TERMINATION RESISTORS OF 120 OHMS MUST BE PLACED AT THE PANEL AND AT THE FURTHERMOST TRANSMITTER IN THE CHAIN.

Section 3 Operation

3-1 Introduction

- 3-1.1** The following paragraphs discuss the steps to take when first applying power to the GDCP-A system. Also, discussed are the initial displays after start-up, the default program parameters, how to enter the system and change program parameters, how to check the status of all system parameters and what occurs during and after a power loss.

3-2 Applying Power

- 3-2.1** Power should only be applied when all wiring has been completed and thoroughly checked for accuracy. The GDCP-A Control Panel polls its transmitters at start-up. All transmitters should be connected and ready for operation before applying power. **Power to the transmitters is supplied by a D.C. power supply located in the panel which connects to each transmitter using three of the conductors in the connecting cable.**

After making sure that the breaker at the facility's service panel is in the on position, place the power switch for the panel to the on position as noted on the power supply/relay board located at the back of the panel P.C. package. You will have to open the package door to access this switch. **Please see Fig. 4, page 14, for the location of the panel's power switch. The switch is located on the top, left corner of the P.C. board to the right of the power input terminal strip.**

WARNING

Dangerous, high voltage exists on the panel's power supply/relay board. Be especially careful not to contact any of the terminal points on TS1 or the main power fuse, FH1, while operating the power switch, SW1.

Immediately place the power switch to the off position if you experience any indications of circuit shorting, unexpected noises or smoke. Do not attempt to apply power until the reasons for these happenings are determined and corrected.

- 3-2.2** Once the power switch is in the on position, close the door to the P.C. package. Briefly examine the front panel for the following:

The display should have a message indicating the date and time. There should also be a statement indicating that the unit is warming up and asking the operator to please wait.

The green power indicator at the upper, right corner of the front panel should be glowing.

All other panel indicators should be in their off positions.

If you do not see the indications stated above, place the power switch to the off position and remove the 120 VAC power by placing the breaker in the off position. **Contact you Brasch distributor, or the Brasch factory, for instructions on how to proceed.**

3-3 Initial Displays

3-3.1 Immediately after applying power, the panel power indicator will be glowing and the LCD will display the following message.

```
DATE (DOW) (CURRENT DATE)
TIME (HOURS:MINUTES)
WARMING UP
PLEASE WAIT
```

After about 10 seconds, the panel will enter its startup ventilation mode. If any ventilation zones are programmed to be on, they will actuate at this time. The zone indicators associated with those zones will then glow. The panel will remain in the startup mode for approximately 2 ½ minutes. After this time is completed, the panel will enter the measure mode. The display will then change to the following.

```
DATE (DOW) (CURRENT DATE)
TIME (HOURS:MINUTES)
PRESS MENU KEY
FOR OPTIONS
```

The display updates about every five seconds. If there are any failed transmitters, the display will then indicate the following.

```
DATE (DOW) (CURRENT DATE)
TIME (HOURS:MINUTES)
FAILED SENSOR
CHECK SYSTEM STATUS
```

Press the “MENU” key and the display will then change to the following:

```
PROGRAM SYSTEM

ENT/PREV/NXT
```

Press the “NEXT” key and the display will change to:

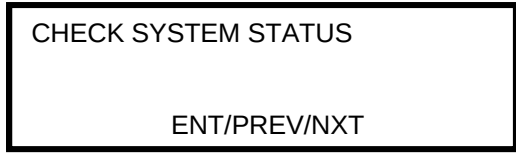

Press the “ENT” key to enter the system status checking mode.

Once the panel is in the status checking mode, you may index to the “CHECK SENSOR STATUS” display using the “NXT” key. You may then press “ENT” followed by “NXT” to check the status of the current sensor number, or use “NXT” to index to a specific sensor number before selecting it by pressing the “ENT” key.

The second line of the display will either indicate the current reading of the sensor, or indicate that the sensor is in the failure mode.

Once you have finished checking the sensor status, press the “MENU” key to return to the main panel display.

3-4 Default Program

3-4.1 If you have not asked the factory to ship your new GDCP-A Control Panel with a specific program installed, the panel will arrive with the factory default program active. The following parameters will be set into the program.

- CO transmitters: Low Alert trigger point at **35 PPM**.
The transmitter will be assigned to **output zone #1**.

- NO₂ transmitters: Low Alert trigger point at **1.0 PPM**.
The transmitter will be assigned to **output zone #1**.

- Active Zone: **Zone #1**.

- Zone ON/OFF Delay time: **3 minutes**.

- Type of exhaust: **50%/100%**.

- Auto. Override Active: **NO**.

- Power Back Status: **No fans active after power failure**.

Of course, the High Alert settings remain at **100 PPM for the CO transmitters, and 5 PPM for the nitrogen dioxide transmitters**. These settings are not adjustable.

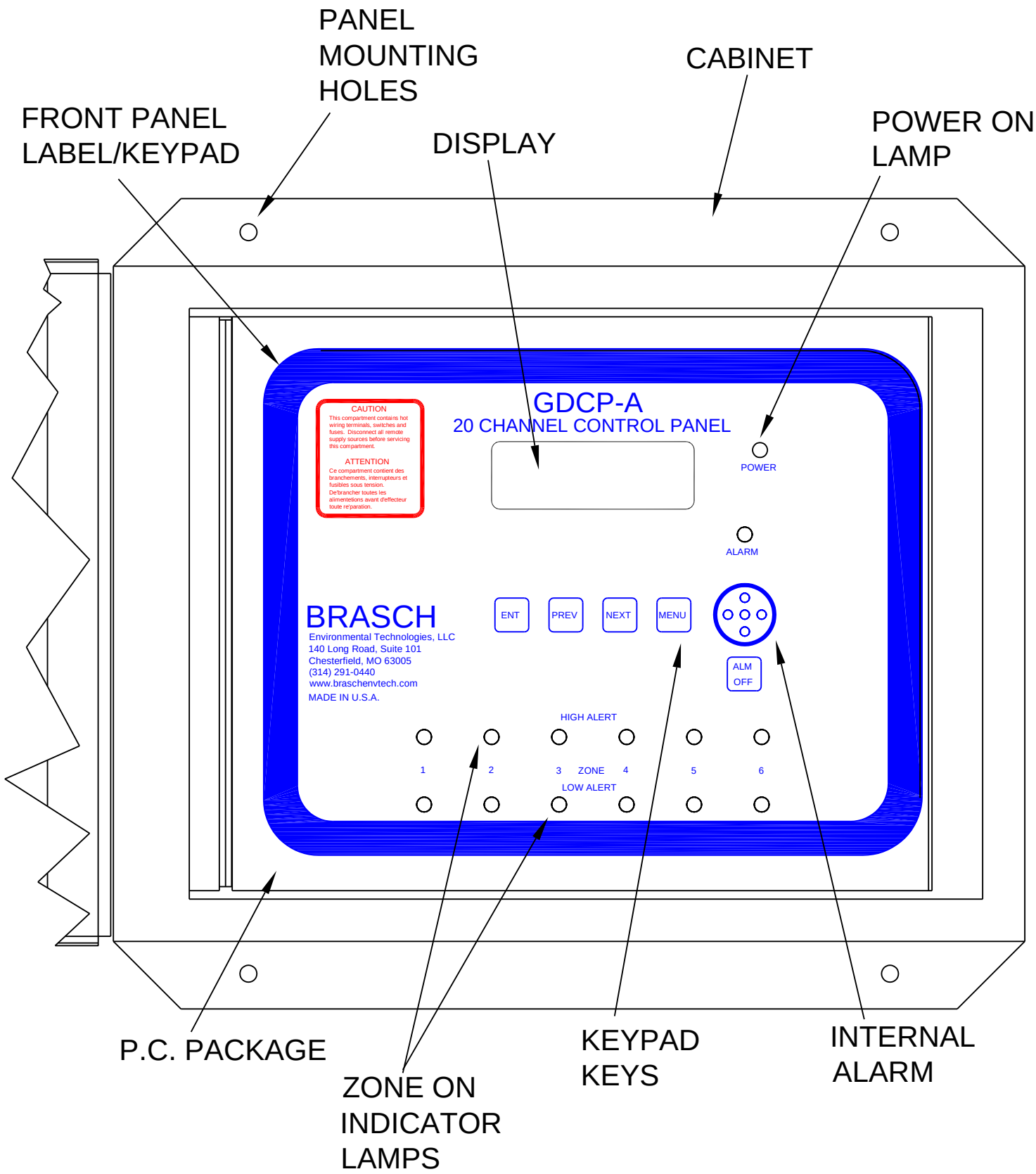

FIG 7: GDCP-A front, internal view of front panel layout.

3-5 Entering or Changing a Program

- 3-5.1** The GDCP-A Control Panel uses a four key keypad and a liquid crystal display to enter or change the programming for the various functions. **Please see Fig. 7, page 21, for the location of the various front panel features.** The routine involves displaying a programming choice on the LCD and waiting for the operator to respond by pressing one of the four keys. Depending upon the key pressed, a parameter is entered into the program, or the next programming choice is presented on the LCD.

To aide with the programming, a list of keys that are active for that portion of the programming routine is presented on the fourth line of the display. However, in most cases, the "MENU" key is also active. Pressing this key will bring the panel back to the main display.

The functions that can be programmed by the operator are detailed below. By pressing the keys in the noted sequence, the operator will be able to program the panel for optimum performance.

3-5.2 Time

Press the following keys in the noted sequence to set or change the time.

Press "MENU"
Press "ENT"
Press "ENT"
Press "NEXT" until hour correct
Press "ENT"
Press "NEXT" until minute correct
Press "ENT"
Press "MENU" for main display

Check the display for the correct time.

3-5.3 Date

Press the following keys in the noted sequence to set or change the date.

Press "MENU"
Press "ENT"
Press "NEXT"
Press "ENT"
Press "NEXT" until day-of-week correct
Press "ENT"
Press "NEXT" until month correct
Press "ENT"
Press "NEXT" until day-of-month correct
Press "ENT"
Press "NEXT" until year correct
Press "ENT"
Press "MENU" for main display

Check the display for the correct date and day-of-week.

3-5.4 Sensors

Press the following keys in the noted sequence to enter or change the sensor program.

Press "MENU"
Press "ENT"
Press "NEXT" until Program Sensor choice
Press "ENT"
Press "NEXT" until sensor number correct
** Press "ENT"
Press "ENT" to choose to set Low Alert PPM
Press "NEXT" until Low Alert PPM correct
Press "ENT"
Press "NEXT" to assign zones to this sensor
Press "ENT"
Press "NEXT" to set zone to ON or OFF
Press "ENT"
* Press "NEXT" to set next zone ON or OFF
Press "ENT"
(* Repeat until six zones are assigned)
Press "NEXT" (if programming more sensors)
(** Jump back to program next sensor)
OR
Press "MENU" (If all sensors programmed)

3-5.5 Zones

Press the following keys in the noted sequence to enter or change the zone program.

Press "MENU"
Press "ENT"
Press "NEXT" until Program Zone choice
Press "ENT"
Press "NEXT" until zone number is correct
* Press "ENT"
Press "NEXT" until exhaust type correct
Press "ENT"
Press "NEXT" until zone delay minutes are correct
Press "ENT"
Press "NEXT" until next zone number correct
(* Jump back to program more zones)
OR
Press "MENU" (If all zones programmed)

3-5.6 Automatic Overrides

Press the following keys in the noted sequence to enter or change the automatic overrides program.

Press "MENU"

Press "ENT"

Press "NEXT" until Program Auto Vent choice is displayed

Press "ENT"

Press "NEXT" until type of automatic override is correct

Press "ENT"

(* If type is BY DAY)

OR

(** If type is EACH HOUR)

* Press "ENT" to set ON/OFF times

Press "NEXT" for choice to program weekdays or weekends

Press "ENT"

Press "NEXT" until time number is correct

Press "NEXT" until ON time is correct

Press "ENT"

Press "NEXT" until OFF time is correct

Press "ENT"

(* Jump back for more times)

OR

** Press "NEXT" until the active zone number is correct

Press "ENT"

Press "NEXT" to set zone ON or OFF

Press "ENT"

(** Jump back to program more zones)

OR

Press "MENU" for main display

3-5.7 Manual Overrides

Press the following keys in the noted sequence to enter or change the manual overrides program.

Press "MENU"

Press "NEXT" until Program Man Vent choice

Press "ENT"

Press "NEXT" until the zone number is correct

* Press "ENT"

Press "NEXT" until ON or OFF choice is correct

Press "ENT"

Press "NEXT" until next zone number is correct

(* Jump back to set the next zone)

OR

Press "MENU" for main display

3-5.8 Power Restore After a Power Interruption

Press the following keys in the noted sequence to enter or change the power restore program.

Press "MENU"

Press "ENT"

Press "NEXT" until Program Power Back choice

Press "ENT"

Press "NEXT" until active zone number is correct

* Press "NEXT" until ON or OFF choice is correct

Press "ENT"

(* Jump back to set the next active zone)

OR

Press "MENU" for the main display

3-6 Status Check

3-6.1 The status of the programmable functions that can be checked by the operator are detailed below. By pressing the keys in the noted sequence, the operator will be able to read the status of these specific functions.

3-6.2 Sensors

Press the following keys in the noted sequence to read the status of the sensors.

Press "MENU"

Press "NEXT" until Check System Status is correct

Press "ENT"

Press "NEXT" until Sensor Status is correct

* Press "ENT"

Press "NEXT" until sensor number is correct

Press "ENT" to read sensor Low Alert trigger point

Press "NEXT" to read actual sensor concentration

Press "NEXT" to read zones assigned to this sensor

Press "NEXT" to choose next sensor

(* Jump back to check more sensors)

OR

Press "MENU" for main display

3-6.3 Zones

Press the following keys in the noted sequence to read the status of the zones.

Press "MENU"

Press "NEXT" until Check System Status is correct

Press "ENT"

Press "ENT" to choose zone status check

* Press "NEXT" until zone number is correct

Press "ENT" to read the exhaust type

Press "NEXT" to read the zone delay time in minutes

Press "NEXT" to read more zones

(* Jump back to check the status of more zones)

OR

Press "MENU" for main display

3-6.4 Automatic Overrides

Press the following keys in the noted sequence to read the status of the automatic overrides **if set for each hour.**

Press "MENU"

Press "NEXT" until Check System Status is correct

Press "ENT"

Press "NEXT" until Auto Vent Status is correct

Press "ENT" to read type of automatic ventilation and ON time

Press "NEXT" to read the active zones

Press "NEXT" to return to Program System choice

Press "MENU" for main display

Press the following keys in the noted sequence to read the status of the automatic overrides **if set by day.**

Press "MENU"

Press "NEXT" until Check System Status is correct

Press "ENT"

Press "NEXT" until Auto Vent Status is correct

Press "ENT" to read the type of automatic ventilation

Press "NEXT" to read weekday time #1 ON time

Press "NEXT" to read weekday time #1 OFF time

Press "NEXT" to read weekday time #2 ON time

Press "NEXT" to read weekday time #2 OFF time

Press "NEXT" to read weekday time #3 ON time

Press "NEXT" to read weekday time #3 OFF time

(Continue to press "NEXT" to read weekend time settings.)

Press "NEXT" to read the active zones

Press "NEXT" to return to Program System choice

Press "MENU" to return to main display

3-7 Loss of Power

3-7.1 Operation During Power Loss

The GDCP-A Control Panel stores all of its programmable parameters in the memory section of the real time clock, (**RTC**), circuit. A battery, built in to the RTC, allows the stored parameters to be retained for as long as 10 years if the circuit loses power. Once the power is restored to the system, the system microprocessor retrieves these stored parameters from the RTC. Therefore, the control panel can resume its operation in the same manner as it was before the power loss.

During a power loss, the Low Alert relays contacts of each zone automatically close. Any ventilating equipment connected to these relay that retains power will operate. Once the power returns, the ventilating equipment will function according to the programming of the **power restore routine**. This routine can be programmed to actuate specific equipment, or leave all equipment off, for a period of 2 ½ minutes. After this period, the control panel will operate the ventilating equipment according to the data acquired from the sensors.

3-7.2 Operation After Power Returns

3-7.2.1 Power Restore Without Ventilation

The system can be programmed to leave all ventilating equipment off for a period of 2 ½ minutes after the power is restored to the system. At the end of this period, the system will function according to the parameters programmed into the system by the user prior to losing power.

3-7.2.2 Power Restore With Ventilation

If desired, the system can be programmed to actuate specific ventilating equipment for a period of 2 ½ minutes after power is returned. Please see **section 3-5.8** for the steps to follow in programming this power back function. Once the 2 ½ minute period is over, the system will operate according to the user program.

Section 4 Maintenance

4-1 Introduction

4-1.1 The following paragraphs cover the areas of the GDCP-A system that require periodic attention to ensure continued optimal performance. The areas included are sensors lifetimes, fuses and sensor sensitivity testing.

4-2 Maintenance

4-2.1 Sensors

The GDCP-A requires very little maintenance. The sensors used in the transmitters have a two year lifetime for the nitrogen dioxide transmitter while the sensor in the CO transmitter is rated at five years. Unless the sensors are exposed to abnormal levels of gases, or fumes from materials such as paints, cleaning fluids and the like, the sensors should easily work for the rated periods.

After the sensors reach their end-of-life periods, they can be replaced with a factory calibrated P.C. board/sensor assembly. Once replaced, the transmitters should function for the rated life times of the new sensors without problems.

4-2.2 Fuses

The GDCP-A and the transmitters are protected by fuses of various ratings. These fuses are of the TR5 type and simply plug into a fuse holder on the associated P.C. boards. These fuses can fail for various reasons. Power supply spikes that occur during, and after, power losses can sometimes stress the fuses and cause them to fail. This is no fault of the equipment, and, in most cases, replacing the fuse solves the problem.

The fuses can also fail when large currents, caused by a failed component, passes through them. In this case, the replacement fuse will most likely fail also. **If you encounter this situation, please contact your nearest Brasch distributor for help.**

Each GDCP-A system ships with a limited number of replacements fuses. If you find that you require a larger number of fuses, please contact your distributor to order a factory fuse kit. This kit includes 10 to 20 each of the various sizes of fuses required for the system.

Repeated fuse failures may be an indication of high service voltage levels, or a component in the GDCP-A system that is on the verge of failure. Contact your distributor to discuss this condition.

4.2.3 Sensitivity Testing

Some localities may require you to determine that the sensors are remaining accurate and calibrated. If you are required to perform these tests, please contact your distributor, or Brasch Environmental Technologies directly, for options on how these tests may be accomplished.

Section 5 Service and Repair

5-1 Introduction

5-1.1 The following paragraphs discuss the warranty policy and the procedure on how to obtain service and repair. The full warranty statement can be found on **page 5** of this manual.

5-2 Warranty Period

5-2.1 The GDCP-A Control Panel and its associated transmitters are warranted for a period of **one year from the date of shipment** against failure caused by defects in material or workmanship. If a product manufactured by Brasch Environmental Technologies, LLC. should fail through no fault of the user, the Company will repair, or replace, that product with no charge for the parts or labor during the warranty period. The decision to repair or replace the product will be a decision made by Brasch. When making this decision, the requirements of the customer will be a factor.

5-3 Obtaining Service

5-3.1 Service and Repair Procedures

Our goal at Brasch Environmental Technologies is to produce products that constantly exceed the requirements and expectations of our customers. One of the ways of meeting that goal is to produce products that never fail or require service. However, when we are notified of a problem with one of our products, it is our intention to address the problem as quickly and efficiently as possible.

Many problems that appear at first to be associated with the product can be solved without returning the product. If you experience a problem, and would like to discuss it with a factory service technician, you may call the number listed on the product label. You will be transferred to a technician specially trained to service that specific product. This technician will help you determine the most efficient way of solving the problem.

If service or repair of your Brasch product becomes necessary, an authorization request for returning the product to the Brasch factory must be obtained from our sales office. If you are an end user, please contact your Brasch distributor to initiate this request. The distributor, after obtaining a description of the problem, will contact the factory and request a **Return Goods Tag, (RGT)**, number. This number must be placed in a conspicuous location on the outside of the shipping package. **Without this RGT number, Brasch will not accept the shipment.** A brief description of the reason for returning the product should be included in the package. Without this description, repair may take longer than necessary.

You may at the time you request service, request an estimate on the time it will take for repair. The Brasch representative will give you an estimate based upon the information you provide. Although Brasch Environmental Technologies will repair and return your product in as short a time as possible, Brasch cannot be held responsible for meeting repair estimates.

APPENDIX B

Description of 4-20 milliamps, multiplexed signal output.

The GDCP-A Control Panel can send an analog signal to external systems such as building management systems, (BMS). This signal can be used by the BMS to trigger remote alarms, data storage systems and the like.

The signal is sent over one 4-20 milliamp output cable. The cable is a two conductor, shielded type, with the shield connected to the earth ground at one point only. Regardless of the number of transmitters in the system, only one signal cable is required. The individual transmitter outputs are time-multiplexed over this one cable. The output of the cable is monitored at the receiving end, and the individual signals from each transmitter is determined by its time displacement from a start pulse that is sent out on the same cable just before the signal from transmitter number one is sent. Each transmitter's signal follows, in sequence, at a preset time displacement, from the previous signal. When all transmitter signals have been sent, the start pulse is again transmitted and the entire signal sequence is repeated using the latest data.

The start pulse consists of a 2.0 milliamp level of four second duration. At the end of this four second pulse, a two second duration pulse is transmitted at a level corresponding to the concentration sensed by the first transmitter. This level will be between 4.0 milliamps, (0 PPM) and 20 milliamps, (the transmitter's full scale value). If the transmitter has failed, this level will be at 0.0 milliamps.

As an example, if the transmitter is monitoring for carbon monoxide, and the concentration is at 35 PPM, the transmitted signal will be a two second pulse at 6.80 milliamps. At the end of the two seconds, the signal from transmitter number one will be replaced with the signal from transmitter number two. This signal will continue for two seconds, also.

In a system with six transmitters, the total signal time from the beginning of the start pulse to the end of the sixth transmitter's signal will be a total time of 16 seconds. This time frame will consist of one four second start pulse followed by six, two second signal pulses. The four second start pulse will then repeat to indicate to the receiving system that the current sequence has completed, and the next sequence is beginning.

FIG. 9 shows the signals from this six transmitter system as a chart of signal level vs. time in seconds.

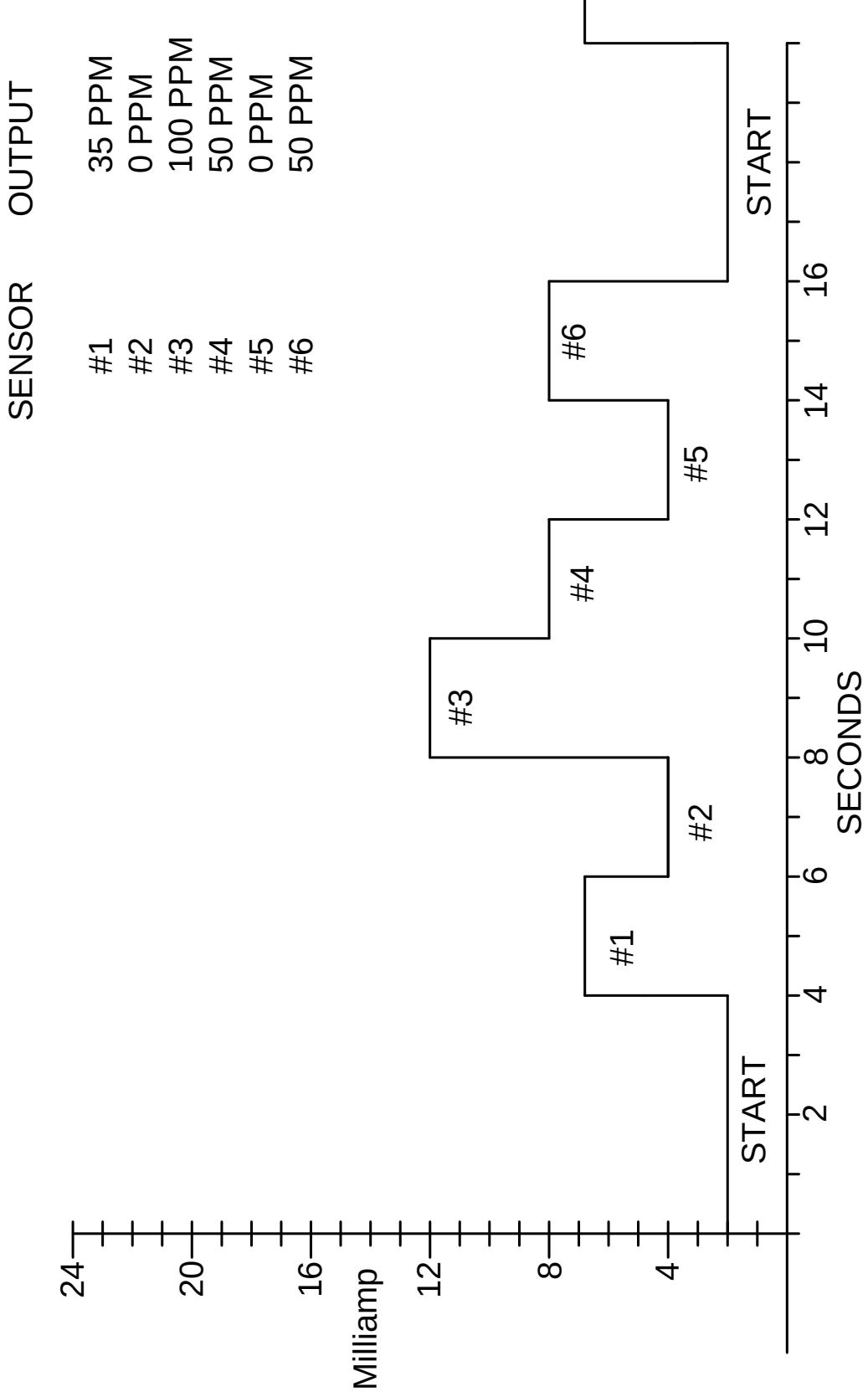
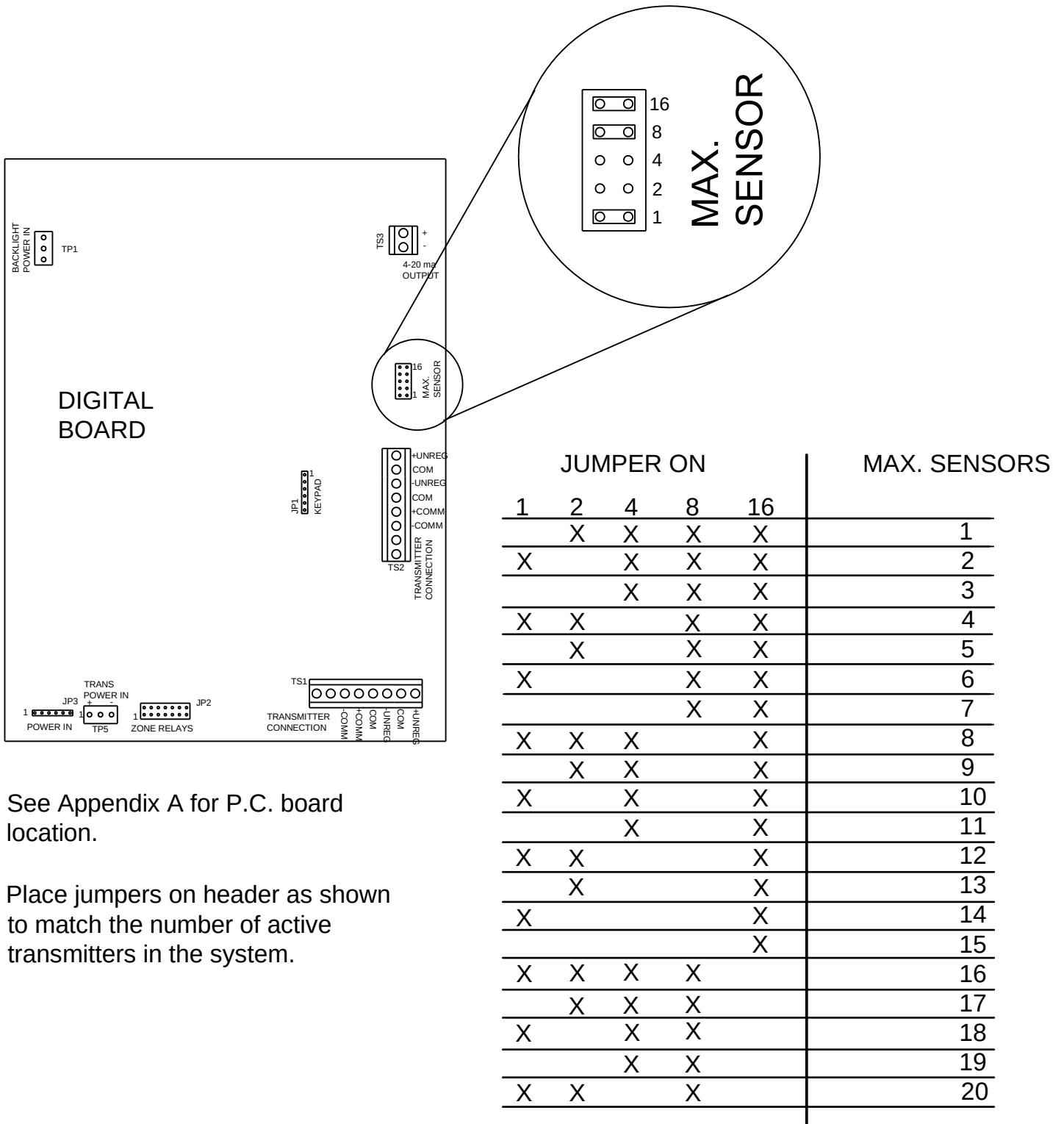

FIG. 9: 4-20 milliamp time multiplexed output for GDCCP-A system with six transmitters.

APPENDIX C



See Appendix A for P.C. board location.

Place jumpers on header as shown to match the number of active transmitters in the system.

FIG. 10: Setting jumpers for maximum number of transmitters.

APPENDIX D

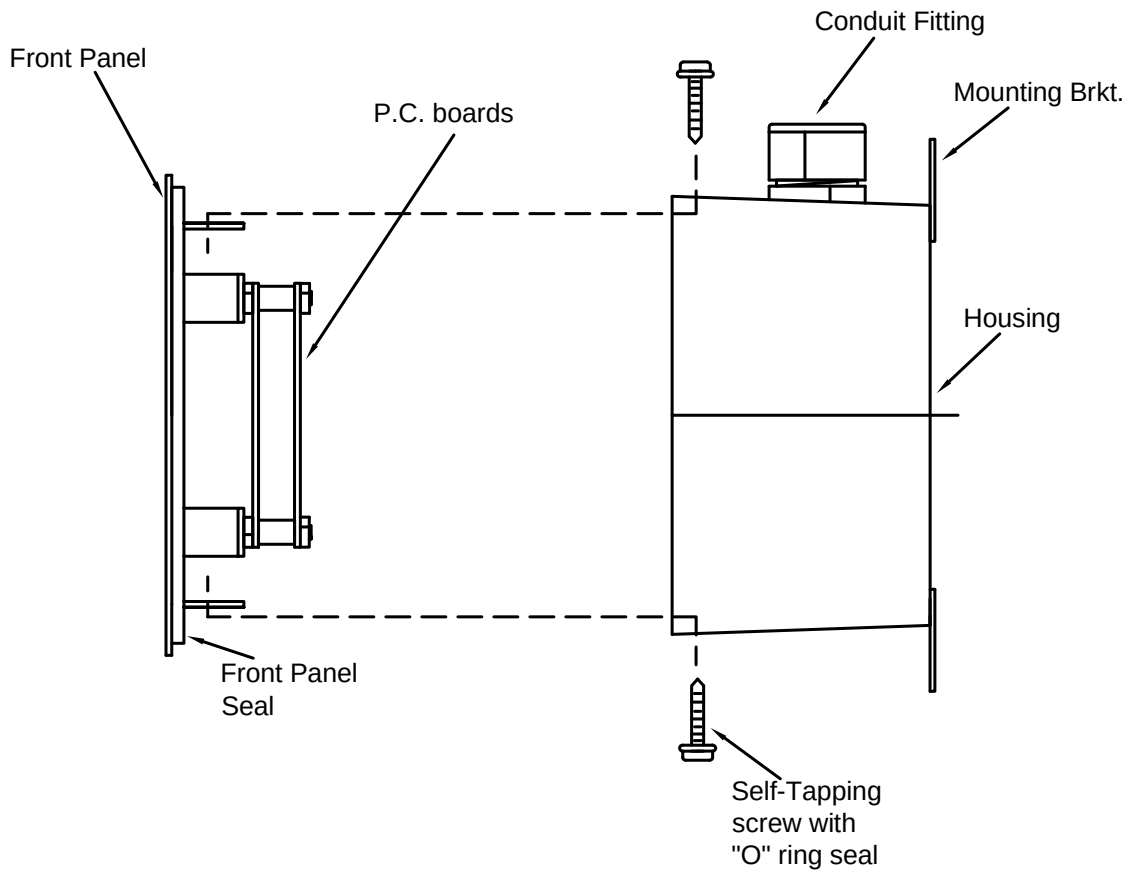

Transmitter assembly, models GSE-CM-TRA and GSE-ND-TRA.

APPENDIX E

List of Low Alert values for CO and NO₂ transmitters

Transmitter	Range of Values
CO:	20, 25, 30, 35, 40, 45, 50, 55 PPM
NO ₂ :	1.0, 1.5, 2.0, 2.5, 3.0, 3.5, 4.0, 4.5 PPM

High Alert values for CO and NO₂ transmitters

Transmitter	Value
CO:	100 PPM
NO ₂ :	5.0 PPM

List of Delay values for entrance and exit delays

	Value in minutes
All Zones:	0.0, 1.0, 2.0, 3.0, 4.0, 5.0, 6.0, 7.0, 8.0, 9.0, 10.0